

Double Decker 14 Lane Food Chute

VIBC14



- All stainless steel construction
- Up to 14 product lanes
- Heat lamps controlled by variable dimmer controls
- Complete with lane listing strips and holders
- Independently controlled decks

Double Decker 14 Lane Food Chute Specification Page

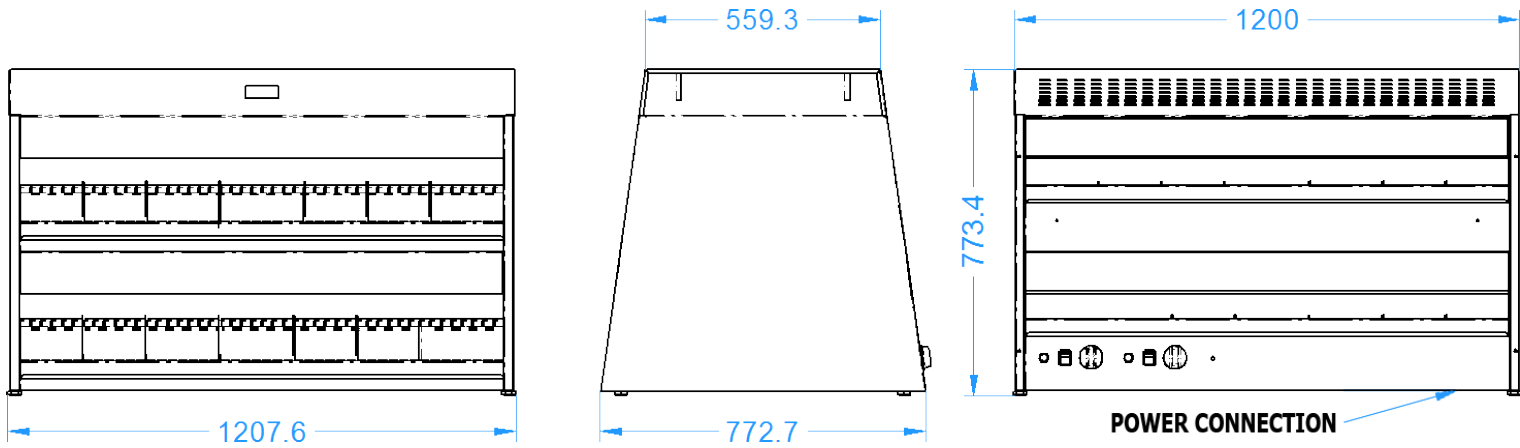

Model VIBC14

Dimensions	Machine
Height	785mm
Width	1200mm
Depth	790mm
Weight	95 kg
Electrical	1 phase, 50HZ AC, 230v, 4.2Kw
Running Amps	20 Amps
Connection Type	2m BESCHUKO Euro cable with, MFEUROCONVERT Euro to UK converter plug
International Option	NA

All *Vizu Food Chutes* have been tested and checked for proper operation before leaving the factory.

Upon delivery please check the unit for damage. If the unit is damaged, contact the carrier, or fast food systems, immediately and file a damage claim (found in the back of the manual) Please retain all packing materials.

Damage must be reported within 7 days of delivery

General Description

The unit has been designed to hold burgers and other cooked, wrapped or boxed foods ready for service.

Assembly Instructions

Remove all packing from the units.

Peel off all protective plastic covering from the metal

Wash all removable parts in warm, soapy water and dry them thoroughly

Place dividers into position. Note: 6 tier.

Installation

Position the Vizu Food Chute in its desired position, close to a suitable electrical supply and connect.

NOTE: THIS UNIT IS SINGLE PHASE SO NO PLUG WILL BE SUPPLIED, CABLE SPECIFICATION MAY VARY, SEE RED BOX ON BACK PAGE

Operating Instructions

1. Switch the two red rocker switches "ON" to operate the top and bottom lights and ceramic elements.
2. Allow unit 15 minutes to pre-heat.
3. Twist the two big black dials into desired position.
4. The top dial controls the top ceramic elements.
5. The bottom dial controls the lower ceramic elements and the under chute heat mat.
6. Start with "1" and adjust upwards slowly until the optimum temperature is reached. In certain cases this additional heat source will not be required. The thermostats are limited to position 4 set as "Maximum".

Cleaning Instructions

1. Disconnect the unit from its power supply.
2. Remove chutes and dividers – clean thoroughly.
3. Clean all stainless steel surfaces with proprietary stainless steel cleaner, such as Sheila Shine and a soft lint free cloth.

Note: Do NOT use abrasive cleaners or pads and do NOT use bleach.

4. Wipe ceramic elements when they are cold with a damp clean cloth.
5. Do NOT touch or clean (quartz) heat lamps with fingers as this will reduce the life of the tubes.
6. Dry all surfaces thoroughly removing all moisture.
7. Replace chutes and dividers -re-connect to power supply.











Faultfinder

Any servicing must be carried out by qualified personnel.

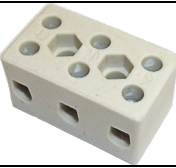





Disconnect from power before servicing.

Problem	Possible Cause	Solution
Indicated ON / OFF switch does not light up	<ul style="list-style-type: none"> - No power to machine - Both switches are faulty 	<ul style="list-style-type: none"> - Check machine is plugged in and switched ON. - Check circuit breaker at main supply board is in i.e. ON position - Replace switches
Indicated ON / OFF switches light up but all or part of heat & lighting does not work	<ul style="list-style-type: none"> - Faulty fuse(s) - Faulty ON / OFF switch(es) - Energy regulator(s) faulty - Dimmer(s) faulty (lights) - Faulty element(s) (heat) - Faulty lamp(s) (light) 	<ul style="list-style-type: none"> - Replace fuse(s) - Replace switch(es) - Replace regulator(s) - Replace dimmer - Replace elements - Replace lamp(s)
Upper lights do not switch on Dimmer Switch = LIGHT	<ul style="list-style-type: none"> - Fuse blown - Dimmer faulty - Lamp faulty - Switch faulty - Section over temperature (allow to cool) 	<ul style="list-style-type: none"> - Check fuse, if blown find reason for fuse blowing before switching back on - Check position on the dimmer switch - Replace lamp - Replace switch - Replace dimmer
Upper section does not heat up or reach temperature required	<ul style="list-style-type: none"> - Heating control set to low - One or both porcelain heater faulty 	<ul style="list-style-type: none"> - Increase temperature setting - Replace faulty heater(s)
Lower section does not reach temperature required	<ul style="list-style-type: none"> - Mat heat element faulty - Energy regulator faulty - Fuse blown 	<ul style="list-style-type: none"> - Replace mat element - Replace control switch - Allow to cool - Check fuse

Spare Parts Listing

PART NO.	DESCRIPTION	QTY.	IMAGE
MF300WRJ	300W jacketed Ir quartz lamp 118mm (used in lower sections)	2	
MF100WRJ	IRL 100JV 100W jacketed Ir quartz bulb (used in upper sections)	2	
MF354Z	2 Pole 5amp term block TB06	17	
MFOHSL01	High temperature sleeving	1	
MF464-9845	3 Way Ceramic Block TB08	1	
MF605-649	Grommet	1	
MFQUARTZJACKET 100W	Jacket Lamp Assembly 100W	2	
MFQUARTZJACKET 300V	Jacket Lamp Assembly 300W	2	
MFCOMMON1	Label 5 140mm x 53mm	1	
EQVIZULABELS	MQ4658CR Vizu labels (10 PER SET)	3	OOS
MFE5057071010	50.57071.010 regulator + 524.010 knob	2	
MF655-638	A01410 CSR2-10E Dimmer	2	

PART NO.	DESCRIPTION	QTY.	IMAGE
MFELBCE500W	590mm x 450mm 230V 500W limiter mat	2	
MFFSC300W	Infra-red ceramic heaters (318-334)	8	
MFRTH34AFM	Adjusted (feet) Rth34Afm0839 49537	4	
MF498-873	Control knob	2	
VILE14	Switch cover / bezel HD2/HD4 MFF1025 / MF1026	2	
VISW15	Green neon rocker Vizu Burger / Passthu	1	
VISW17	Rocker switch HD2 Revolva HD4 MFC1553ALR	1	
MF425-689	Fused DIN Rail Terminal, SAKS Series, 630 V	3	
MF425-768	0191320000, End Plate, SAK Series	2	

PART NO.	DESCRIPTION	QTY.	IMAGE
MF425-780	EWK 1 -206160000, End Bracket, EWK Series	2	
MF412-576	Cartridge Fuse, F, 5A	1	
MF412-582	Cartridge Fuse, F, 7A	1	
MF412-598	Cartridge Fuse, F, 10A	1	
MF543-204	9.5mm Grommet	2	
MF374-1029	10mm low profile lens indicator 230VAC	1	

Exploded Diagram

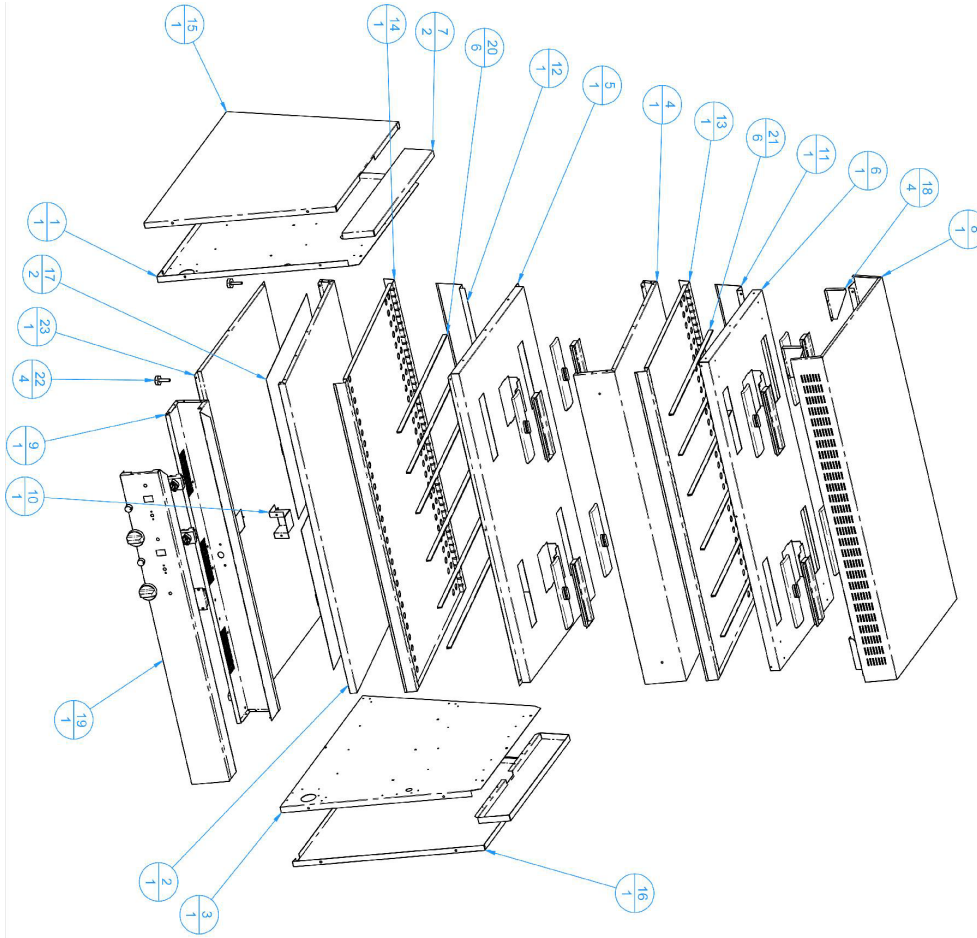

Item	File Name (no extension)	Rev	QT	Material	Sheet
1	0CP-004 INNER SIDE PANEL FOOD CHUTE_A	A	1	Stainless	0.90
2	28-37 LOWER SHELF_A	A	1	Stainless	0.90
3	0CP-004 INNER SIDE PANEL FOOD CHUTE_A	A	1	Stainless	0.90
4	28-10 UPPER SHELF_B	B	1	STAINLESS	0.90
5	28A07 LWR LIGHT ASSY		1		
6	28A06 TOP LIGHT ASSY		1		
7	0CP-016 PT HOOD ENDS		2	Stainless	0.90
8	28-04 HOOD_A	A	1	Stainless	0.90
9	28-32 ELECTRICAL CONTROL BOX_A	A	1	Stainless	0.90
10	28-31 CABLE CLEARANCE BOX		1	Stainless	1.20
11	28-12 UPPER REFLECTIVE SKIRT_C	C	1	Stainless	0.90
12	28-11 LOWER REFLECTIVE SKIRT_C	C	1	Stainless	0.90
13	28-13 UPPER FOOD CHUTE v0.01	0.01	1	STAINLESS	0.90
14	28-15 LOWER FOOD CHUTE v0.01	0.01	1	Stainless	0.90
15	0CP-005 OUTER SIDES FOOD CHUTE_A	A	1	Stainless	0.90
16	0CP-005 OUTER SIDES FOOD CHUTE OPP_A		1	Stainless	0.90
17	MF ELBC6600W BC8 MAT ELEMENT		2		
18	15-08 HOOD SIDE BRACE		4	Stainless	0.90
19	28A05 CONTROL PANEL ASSY		1		
20	15-18 LOWER FOOD CHUTE DIVIDER_A	A	6		0.90
21	15-19 UPPER FOOD CHUTE DIVIDER_A	A	4		0.90
22	MFRTH344FM ADJUSTABLE FEET		4		
23	28-07 BASE_E	E	1	Stainless	0.90

Wiring Diagram

**VIZU BC14
2 TIER FOOD CHUTE FC14**

**INSTALL 100W LAMP IN
THE UPPER SECTION**



**INSTALL 300W LAMP IN
THE LOWER SECTION**

Wiring Diagram

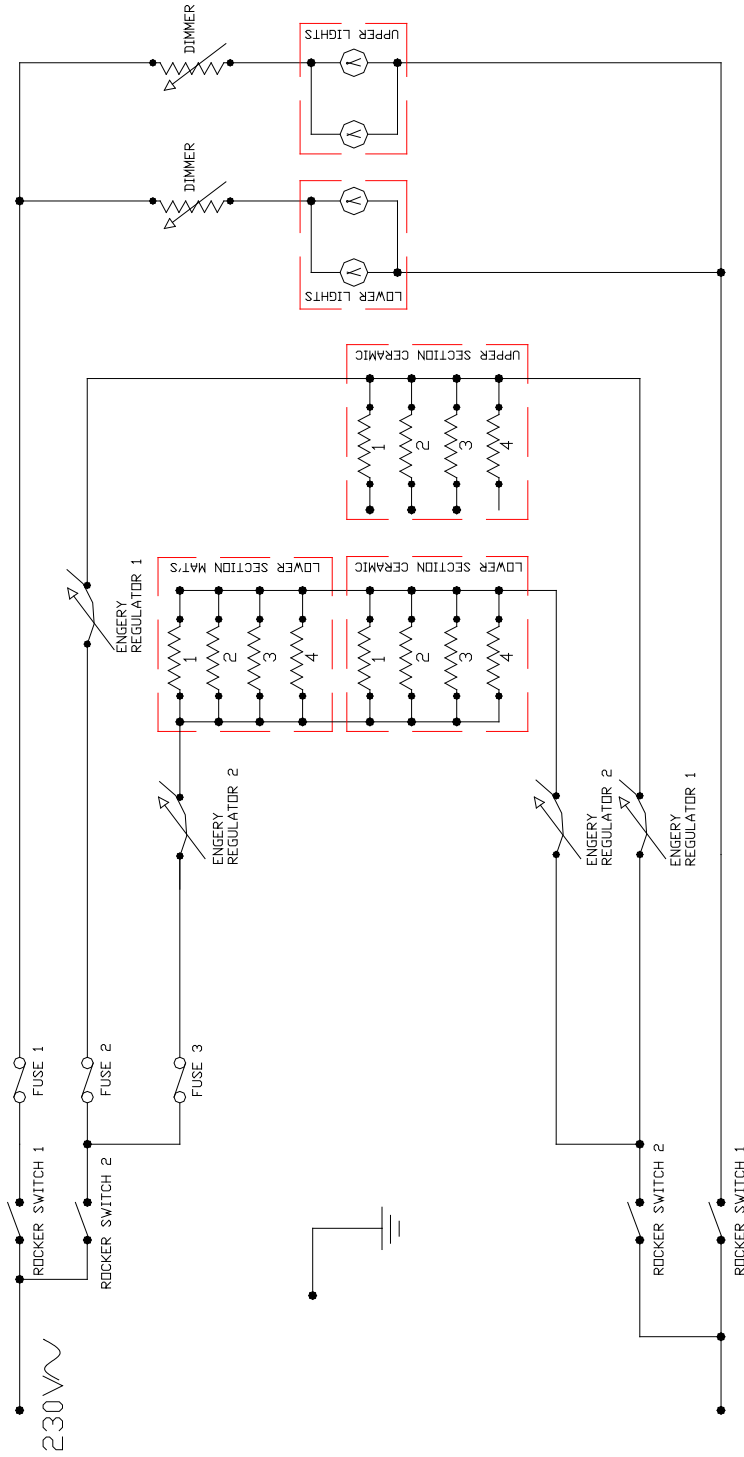

Prototype Name		28 FOOD CHUTE 14		Build No.	
Drawn	Designed	Date	Prototype No.	04	
JMS	RT	16/12/2009	EQVIFC14		
					
Property of Fast Food Systems Ltd. May not be reproduced or used for purposes other than those for which it is supplied without written permission.					
Unit 1, Headley Park 9, Headley Road East Woodley, Reading RG5 4SQ					

WIRING DIAGRAM

Damage claim form

Machine: **Double Decker 14 Lane Food Chute BC14**

Product code: **VIBC14**

Customer name.....

Date of delivery.....

Machine serial number.....

Damage comments.....

.....
.....
.....
.....

Please indicate on the picture where the unit is damaged

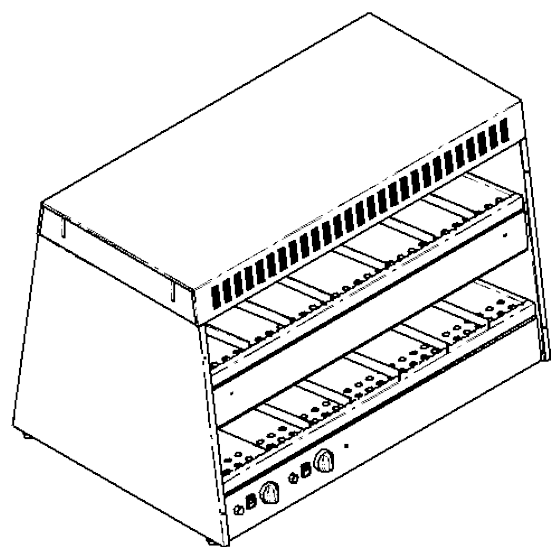
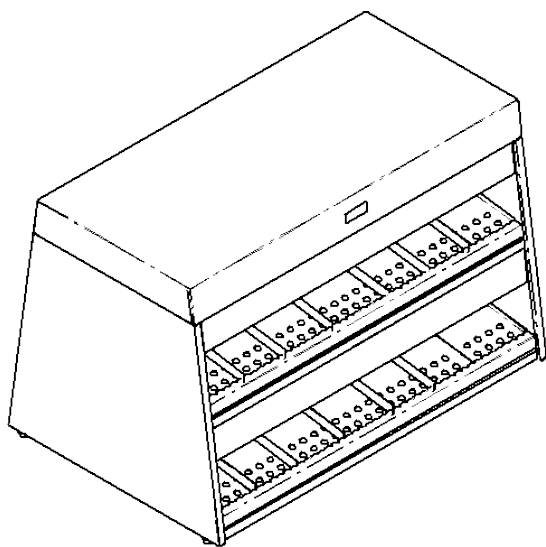

Courier name.....

Please cut this page out and post to *Fast Food Systems*
(The address is on the back of this manual)

Terms and Conditions

Claims

No claim shall be entertained by the Company unless made in writing. Claims arising from damage or partial loss in transit must reach the Company within 7 days from the date of delivery. Claims for non-delivery must reach the Company within 10 days from the date of dispatch. All other claims must reach the Company within 7 days. Damaged goods must be retained for inspection/collection.

Returns

The Company does not operate a returns policy unless the goods are defective:

In circumstances where the Company agrees to accept return of goods, a charge of 25% of the invoice value will be made.

Warranty

UNITED KINGDOM AND REPUBLIC OF IRELAND

Excepting where otherwise specified all products are subject to 12 months parts and labour warranty. Goods found defective will be repaired, credited or replaced without charge according to the terms of the Company's standard warranty, provided written notice is given within the guarantee period. In no case will the company be liable for repairs made without its knowledge or sanction, or for indirect damage, or any consequential loss or expense incurred by purchasers.

Fast Food Systems Ltd, warrants to the original purchaser that the equipment supplied to be free from defective materials or workmanship for a period of 12 (twelve) months.

The following are NOT covered by warranty:

1. Failure or breakdown caused by incorrect installation.
2. Glass parts, electric lamps or door seals.
3. Adjustment or calibration of controls - this is a routine maintenance function.
4. Abuse or misuse, including cleaning.
5. Warranty labour is only carried out during normal working hours, calls attended to out of hours may be subject to surcharges.
6. The warranty will commence either on installation or 1 (one) month from date of dispatch - whichever is the sooner.
7. Warranty on spare parts purchased for equipment outside of the warranty period is 3 (three) months from date of sale.
8. Any faulty spare parts replaced under warranty must be returned with 7 days of supply.
9. Warranty is non-transferable.

Fast-Food-Systems Ltd will not be held responsible, financially or otherwise, for any loss of business as a result of equipment breakdown.

Note...

Model Number.....

Order ID/Job No.....

Machine serial number.....

Date of Manufacture/...../.....

Date of delivery...../...../.....

Date of commissioning...../...../.....



ENGLISH

Electrical equipment marked with this symbol may not be disposed of in European public disposal systems after 12 August 2005. In conformity with European local and national regulations (EU Directive 2002/96/EC), European electrical equipment users must now return old or end-of-life equipment to the manufacturer for disposal at no charge to the user.

Note: For return for recycling, please contact the equipment manufacturer or supplier for instructions on how to return end-of-life equipment for proper disposal.

Fast Food Systems Limited

Manufacturer & Distributor of Catering Equipment

Unit 1 Headley Park 9 Headley Road East

Woodley Reading Berkshire RG5 4SQ

Tel: 0118 944 1100 Fax: 0118 944 0350

Email: service@fast-food-systems.co.uk

Website: www.fast-food-systems.com

ISSUE 10: 10.01.2024